

Vue Eclatée

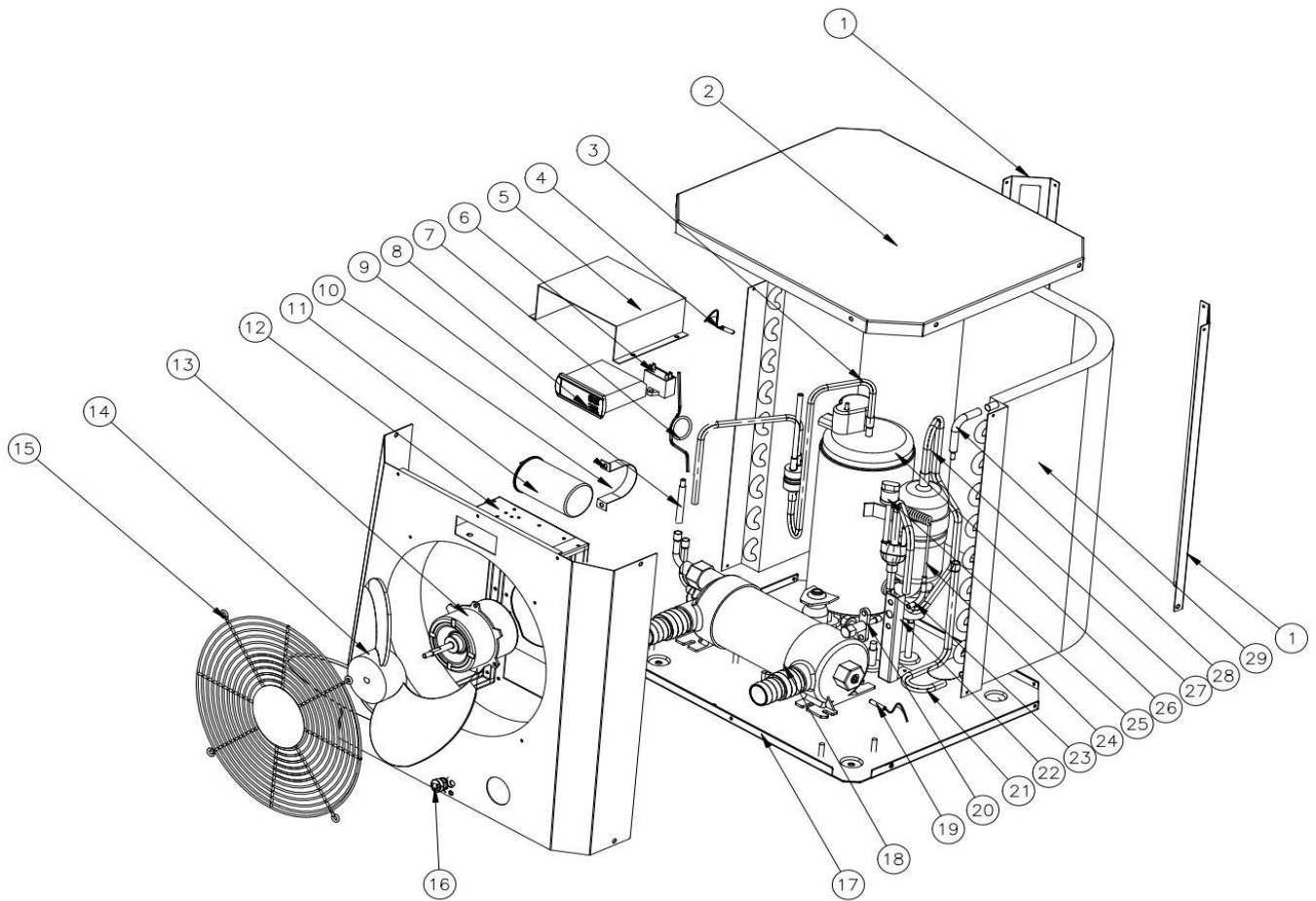

Pompe à Chaleur

Mini

5,5kw

C-11-211034



Pièces Détachées

No.	Code CPF	Référence Fournisseur	Désignation	Code Barres	Conditionnement	PU HT EUR 2020
1		108690009	PILIER ARRIERE GAUCHE			
2		108690008	PANNEAU SUPERIEUR			
3		113010301	TUBE ECHAPPEMENT			
4		117110079	SONDE DE TEMPERATURE AMBIANTE			
5		108690015	COFFRET ELECTRIQUE			
6	C-11-210182	111000034	CONDENSATEUR VENTILATEUR	5020112101827		
7		109000038	CAPILLAIRE			
8		117020189	CONTROLEUR			
9		113420129	TUBE GAZ			
10		108010006	CLIP DE FIXATION CONDENSATEUR			
11	C-11-210181	111000012	CONDENSATEUR COMPRESSEUR	5020112101810		
12		108690023	PANNEAU AVANT			
13	C-11-210184	112000054	MOTEUR VENTILATEUR	5020112101841		
14	C-11-210206	132000024	VENTILATEUR	5020112102060		
15		133020052	GRILLE DE PROTECTION VENTILATEUR			
16		142000126	PASSE CABLE			
17		108690020	BASE			
18		102040746	ECHANGEUR EN TITANE			
19	C-11-210200	117110068	SONDE TEMPERATURE ENTREE D'EAU	5020112102008		
20		120000091	VANNE GAZ			
21		113020316	TUBE GAZ			
22		108680007	TUBE GAZ			
23		113100008	TUBE GAZ			
24		109000048	TUBE GAZ			
25		116000091	SONDE BASSE PRESSION			
26		101000183	COMPRESSEUR			
27		113020316	TUBE GAZ			
28		113100027	TUBE GAZ			
29		103000237	EVAPORATEUR			

